

SPO

SPO SERIES SINGLE POINT LOAD CELLS



Load cells for off center loads, suitable for example to build CE-M approved scales with a single load cell with maximum dimensions of 300x300 mm.

CAPACITIES (kg): 3, 5, 10, 15, 20, 30, 40.

OIML R60. C3 precision class.

Aluminium alloy. **IP67** protection.

The best solution
for advanced industrial
applications

MAIN FEATURES

- C3 PRECISION CLASS
- OFF CENTER LOAD COMPENSATED
- ALUMINIUM ALLOY CONSTRUCTION
- IP67 PROTECTION
- MAX. CAPACITIES FROM 3 TO 40 kg
- FOR PLATFORMS WITH DIMENSIONS UP TO 300 X 300 mm
- SHIELDED CONNECTION CABLE
- OIML AND TEST CERTIFICATES AVAILABLE UPON REQUEST

TECHNICAL FEATURES

- Minimum load cell verification interval:
 $V_{min} = E_{Max}/8.000-15.000$
- Maximum number of verification intervals: $n_{LC} = 3000$
- Full Scale Output: $2mV/V \pm 10\%$
- Temperature effect on zero:
from $\pm 0,0093\% \text{ F.S./10K}$ to $\pm 0,0175\% \text{ F.S./10K}$
- Temperature effect on full scale output:
 $0,0117\% \text{ F.S./10K} (-10^{\circ}\text{C}/+20^{\circ}\text{C})$ $0,0175\% \text{ F.S./10K} (+20^{\circ}\text{C}/+40^{\circ}\text{C})$
- Compensated Temperature Range: $-10^{\circ}\text{C}/+40^{\circ}\text{C}$
- Operating Temperature Range: $-10^{\circ}\text{C}/+50^{\circ}\text{C}$
- Maximum tolerated excitation voltage: 15 VDC
- Input Resistance: 300..500 Ohm
- Output Resistance: 300..500 Ohm
- Insulation Resistance: $>2000 \text{ MOhm}$
- Safe Overload: 150% F.S.
- Ultimate Overload: 300% F.S.
- 4-wire shielded cable, 40cm long, 3,2mm diameter

ATEX Version

- The CCATEX certificate makes the load cell suitable for use in hazardous areas with protection methods according to:
ATEX II 1G Ex ia IIC T6 (Ta $-20^{\circ}\text{C}/+40^{\circ}\text{C}$) TX (Ta $-20^{\circ}\text{C}/+65^{\circ}\text{C}$) Ga
ATEX II 1D Ex ta IIIC TX $^{\circ}\text{C}$ (Ta $-20^{\circ}\text{C}/+40^{\circ}\text{C}$) TX $^{\circ}\text{C}$ (Ta $-20^{\circ}\text{C}/+65^{\circ}\text{C}$) Da IP65.
The certificate includes the manual and the ATEX CE conformity declaration (available in EN, DE, FR, and IT).
- **IMPORTANT:** the certificate refers to the single load cell. For systems with more load cells, it is necessary to order one certificate for each load cell.

DETAIL 1

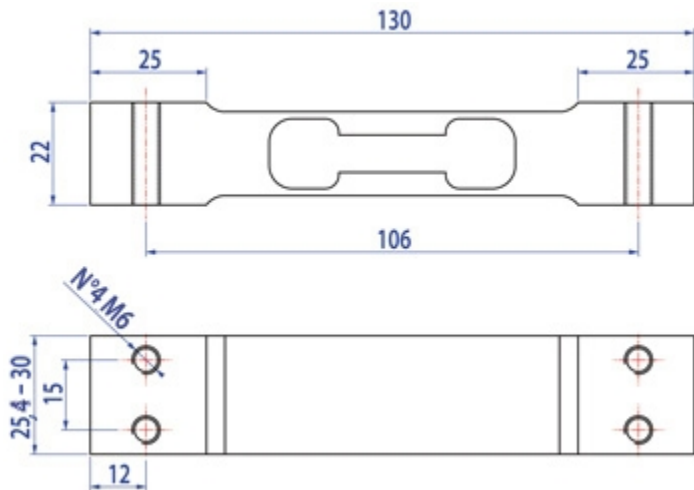







Dimensions in mm

<u>Wiring Code</u>	
<u>Color</u>	<u>Function</u>
YELLOW	SHIELD
WHITE	OUTPUT +
BLUE	INPUT +
RED	OUTPUT -
BLACK	INPUT -

VERSIONS

Available versions

Codice	Piatto Max (mm)	Max (kg)
SPO3-1 	150x150	3
SPO5-1 	300x300	5
SPO10-1 	300x300	10
SPO15-1 	300x300	15
SPO20-1 	300x300	20
SPO30-1 	300x300	30
SPO40-1 	300x300	40



“YOUR WORLDWIDE PARTNER FOR WEIGHING,”

DINI ARGEO
FRANCE sarl
France

DINI ARGEO
GMBH
Germany

DINI ARGEO
UK Ltd
United Kingdom

DINI ARGEO WEIGHING
INSTRUMENTS Ltd
China

DINI ARGEO
OCEANIA
Australia



COMPANY HEADQUARTERS

Via Della Fisica, 20
41042 Spezzano di Fiorano Modena • Italy
Tel. +39.0536 843418

SERVICE ASSISTANCE

Via Dell'Elettronica, 15
41042 Spezzano di Fiorano Modena • Italy
Tel. +39.0536 921784



SALES AND TECHNICAL ASSISTANCE SERVICE